

DESIGNBOARD



Innovatív szerelt burkolatok

+3620 208 4844
info@designboard.hu

designboard.hu





→ Budaörs lakó- és irodaépület

BEMUTATKOZÁS

Cégünk **elhivatott a modern száraz építészeti technológiák** iránt. Falburkolati kínálatunk **innovatív, kiszámítható, megbízható és hatékony megoldást** biztosít megrendelőink számára a közületi és magán szegmensben egyaránt.

Szolgáltatásaink

- műszaki előkészítés → a megvalósíthatóság jegyében
- költség optimalizálás → alternatív ajánlatok kidolgozása
- kivitelezés → komplett szolgáltatás
- kereskedelem → anyag szállítás
- tervezés → látványtervek készítése

Csapatunk célja, hogy az építőipar ezen dinamikusan fejlődő üzletágában megrendelőink számára olyan színvonalú támogatást nyújtson, mely elégedettségre szolgál.



Kiemelkedő dizájn

→ Budaörs lakó- és irodaépület

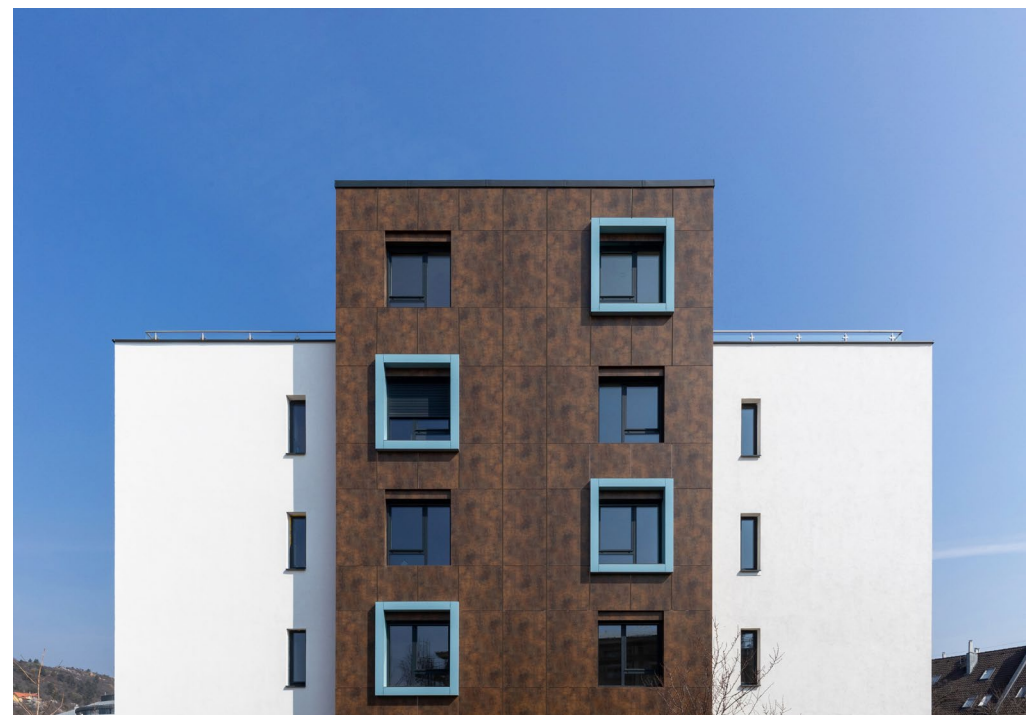

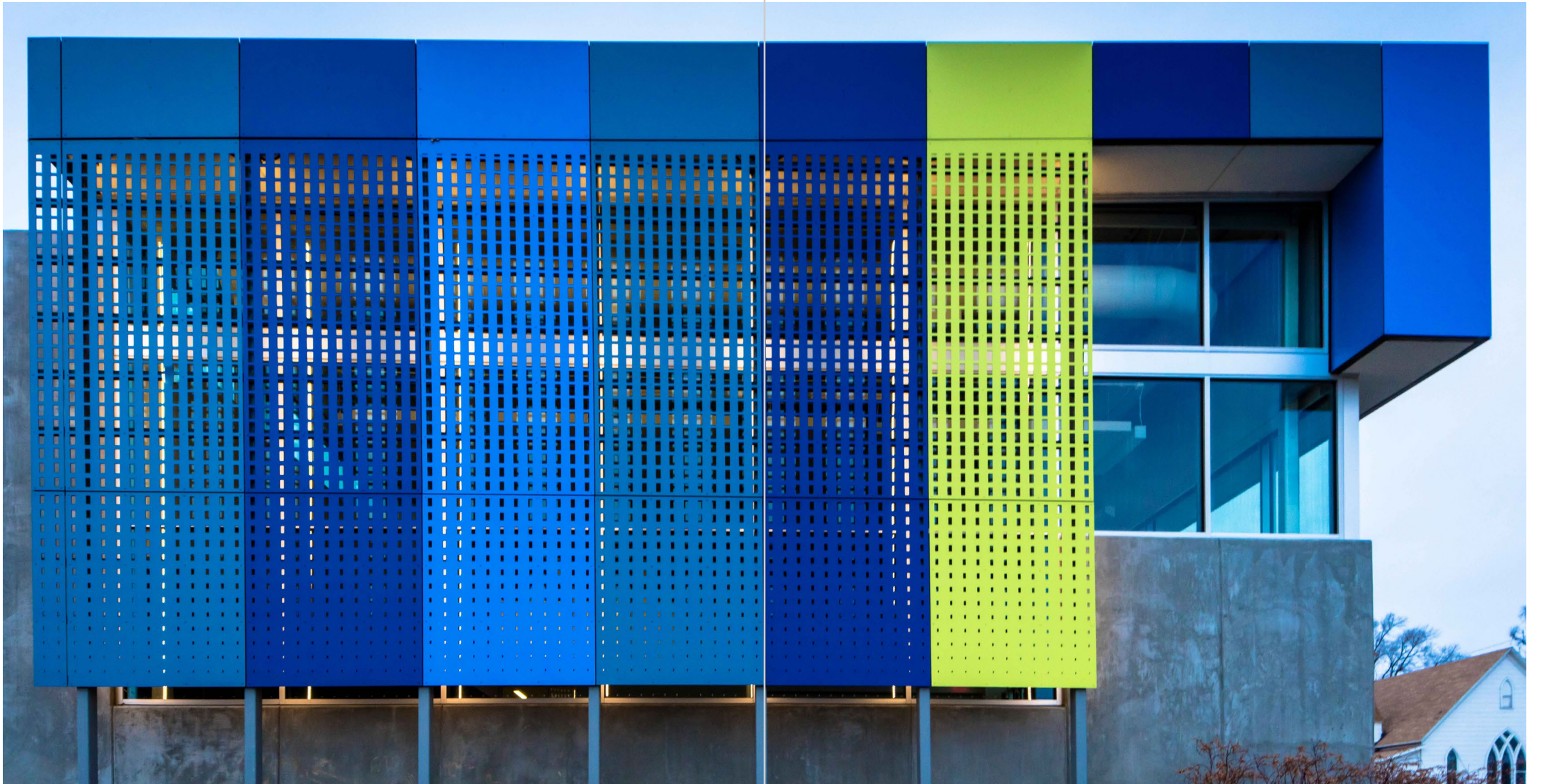

→ Fundermax / árnyékoló



Klasszikus formavilág, modern köntösben

→ Sportcsarnok Fonyód





→ Sportcsarnok Fonyód

Festői környezet kikötői hangulat

→ Siófoki Azúr Port





→ Siófoki Azúr Port





FunderMax & Equitone harmónia



→ LUA Resort Balatonfüred

Luxus panoráma



→ Siósite Siófok







Letisztult elegancia



→ Mercure Hotel Debrecen





DESIGNBOARD



→ Debreceni Egyetem
Innovációs Központ

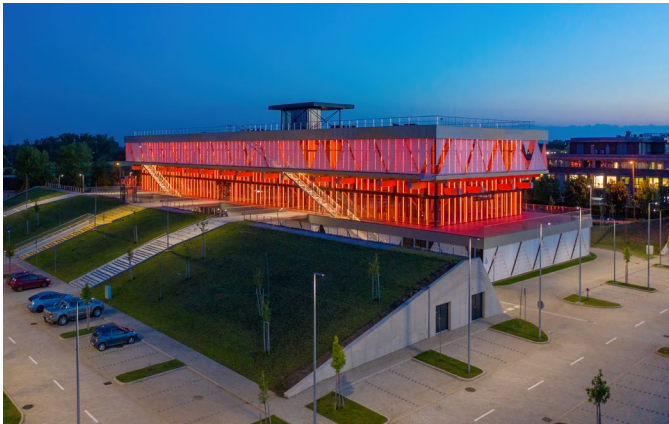

Szálcement és fa





Élénk szín a szürke sportcsarnokban



→ Szent Imre Ciszterci Gimnázium BP





Aréna belsőépítészet

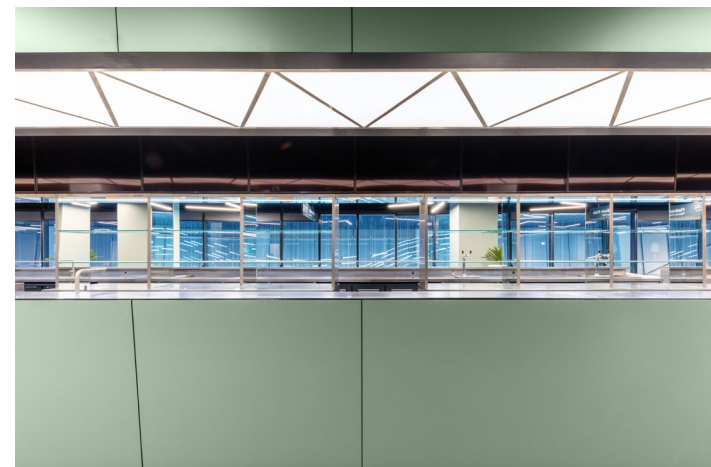

→ MVM Dome BP





Interior

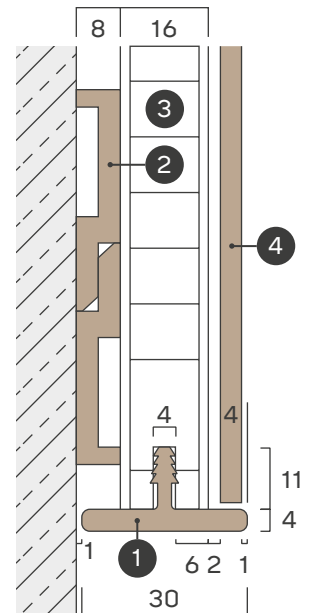
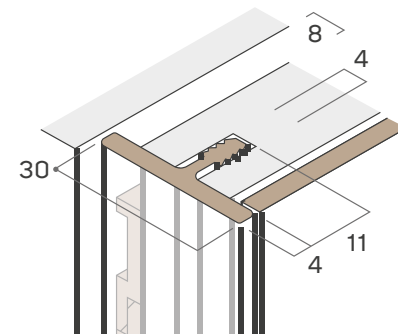

- ① Fuga profil
- ② Alumínium profil
- ③ Burkolat
- ④ Lábazat

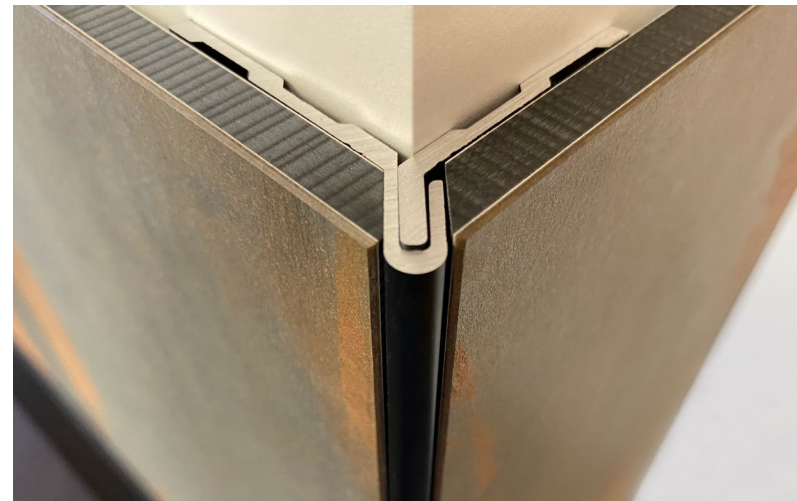
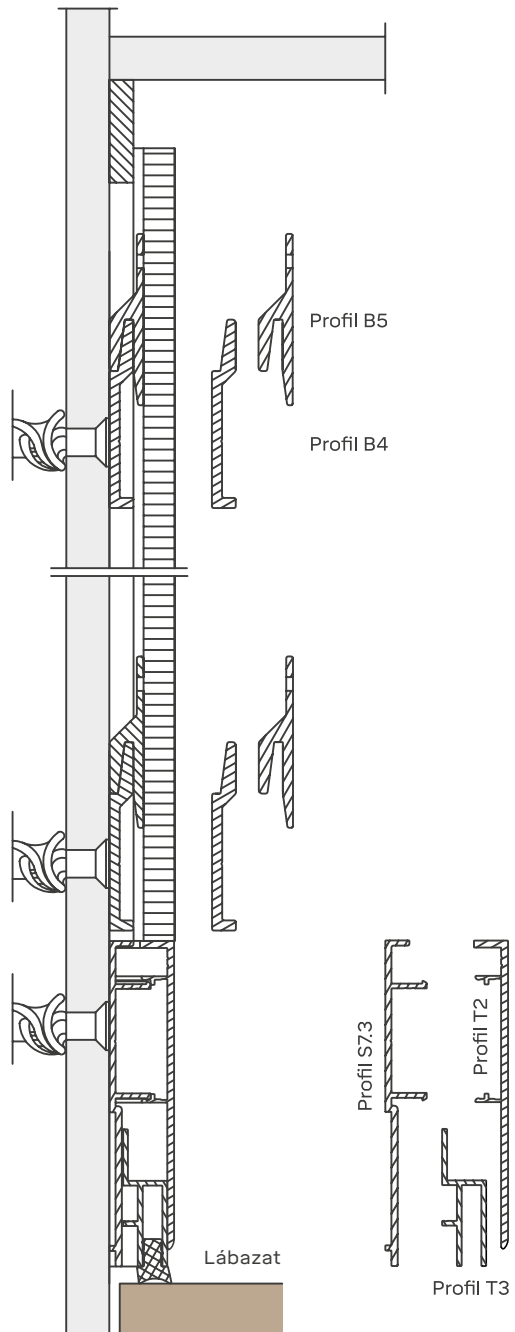



Műszaki adatok

Fundermax látszó rögzítés szegeccsel



For you to create



Fundermax

Max Compact Exterior terhelhetőségi táblázat

Lapvastagság szélteher q (kN/m ²)	6 mm		8 mm		10 mm	
	max b (mm)	max a (mm)	max b	max a	max b	max a
0,50	974	425	1209	417	974	689
1,00	759	295	1012	276	819	410
1,50	620	241	826	271	740	302
2,00	537	208	716	235	689	244

Ausztria*

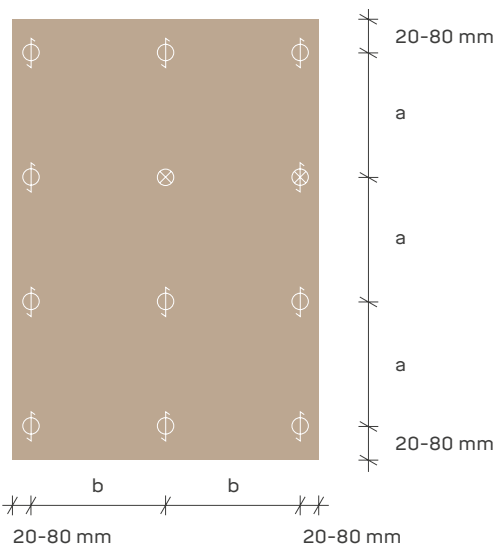

Táblaméretetek

	TK 2140x1060
	GR 2800x1300
	SP 2800x1850
	JU 4100x1300
	XL 4100x1850



Fundermax ragasztott rögzítés

Szerkezeti példa / megfelelő profiltávolság

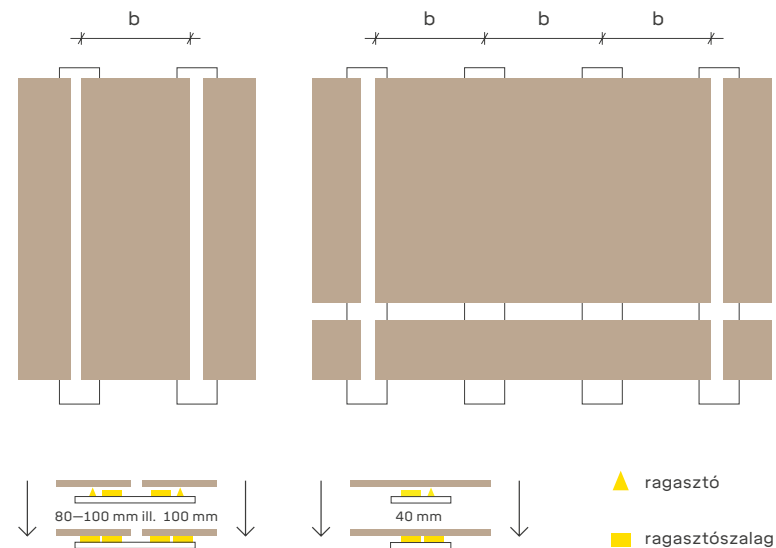

Alátétszerkezeti távolság sika tack panel rendszerrel ragasztott lapokhoz

Lapvastagság	max b	max b
6 mm*	450 mm	500 mm
8-10 mm	600 mm	650 mm

Kerítés és kapu megoldások

Időtálló,
gondozásmentes
esztétikus



Maximális rögzítési távolság

	Lapvastagság	maximum
A1	6 mm	800 mm
A2	8 mm	950 mm
A3	10 mm	1100 mm

Maximális rögzítési távolság

	Rögzítés módja	maximum
B	szegecs	≤ 400 mm
	csavar	≤ 550 mm

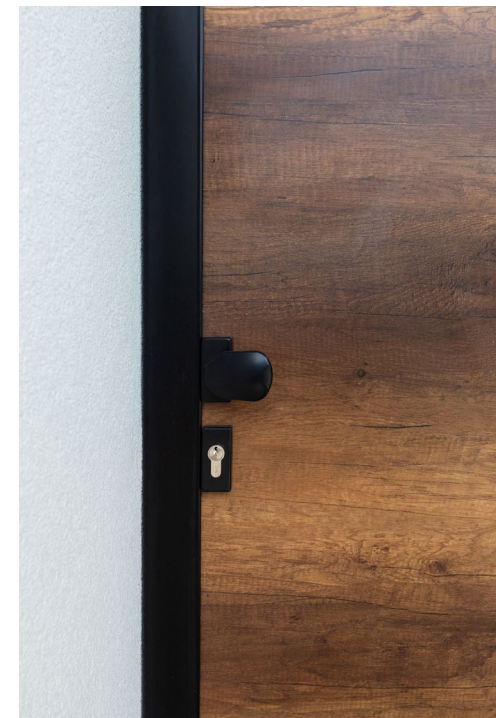

Műszaki adatok

Időtálló, gondozásmentes, esztétikus

Vízszintes szerelés

0803 Tyrol Pine

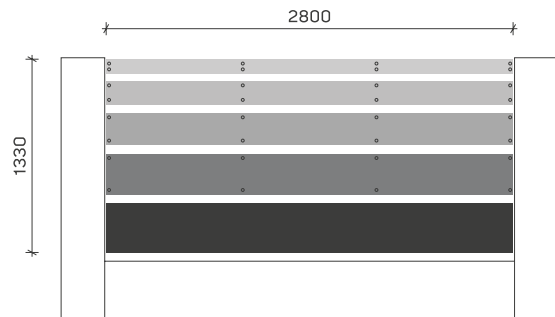
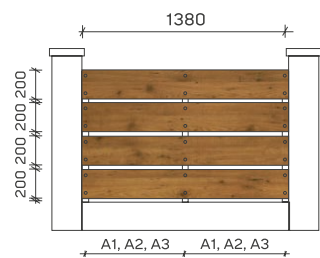

Klasszikus függőleges panel rögzítés

0919 Ecuador

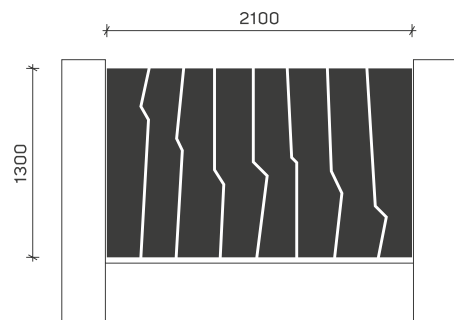

Nagyméretű táblák szerelése

0753 Cool Grey Medium

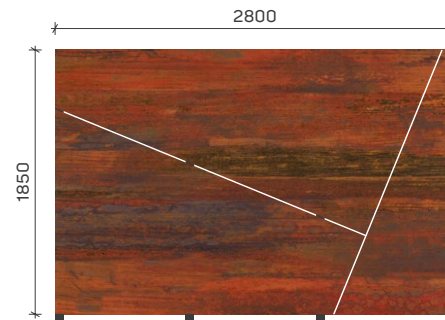
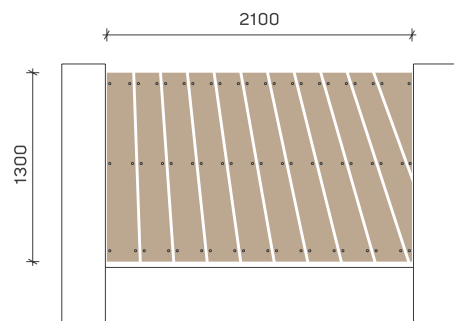
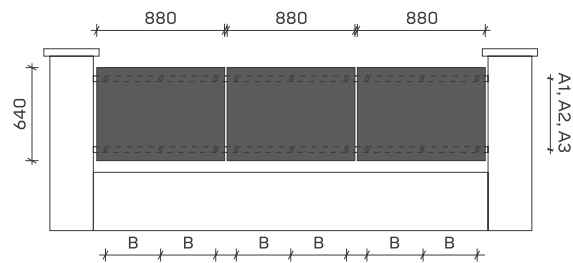

0798 Tambora

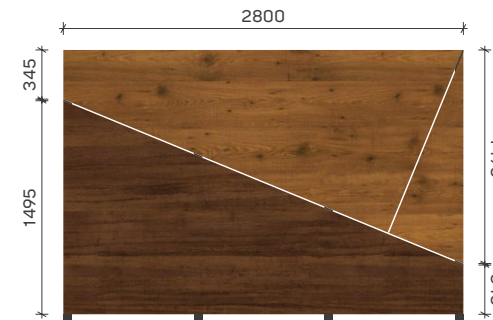

0803 Tyrol Pine / 0922 Amazon

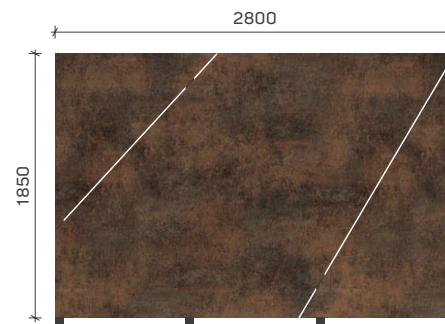

0794 Patina Bronze

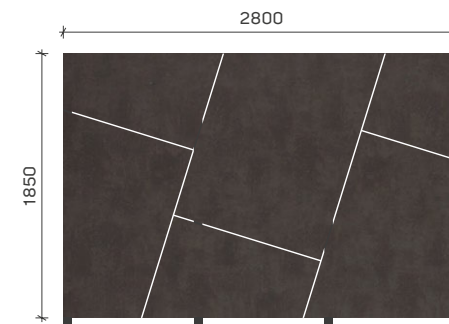

0027 Prado Agate Grey

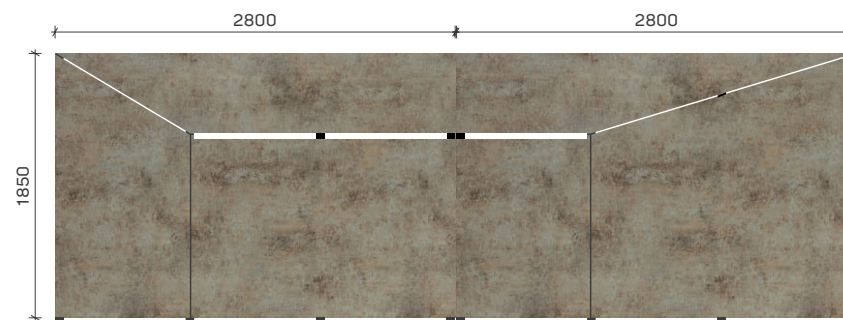

0793 Patina Tin



Szálcement változatok

EQUITONE
Fibre cement facade materials



EQUITONE (lines)

Gyári méretek: 3050/2500 x 1220 mm
Alkalmazási terület: Homlokzat

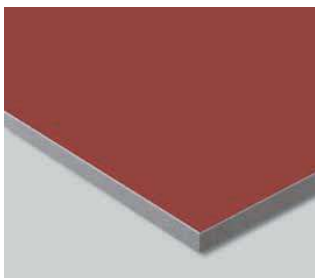

EQUITONE (pictura)

Gyári méretek: 3130/2530 x 1280 mm
Alkalmazási terület: Homlokzat, Tető

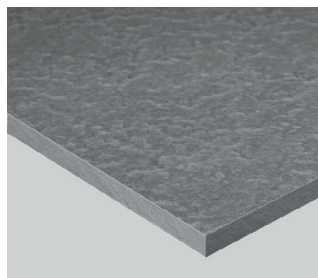

EQUITONE (lunara)

Gyári méretek: 3070/2520 x 1240 mm
Alkalmazási terület: Homlokzat

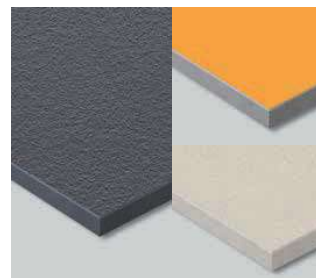

EQUITONE (balcony)

Gyári méretek: 3130/2530 x 1280 mm
Alkalmazási terület: Korlátelem,
Teraszválasztó

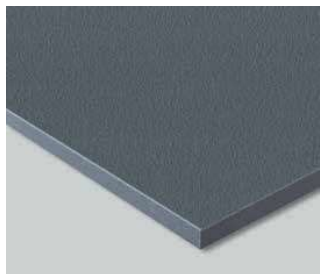

EQUITONE (textura)

Gyári méretek: 3130/2530 x 1280 mm
Alkalmazási terület: Homlokzat, Tető



EQUITONE (tectiva)

Gyári méretek: 3070/2520x1240 mm
Alkalmazási terület: Homlokzat



EQUITONE (natura) PRO

Gyári méretek: 3130/2530 x 1280 mm
Alkalmazási terület: Homlokzat Tető

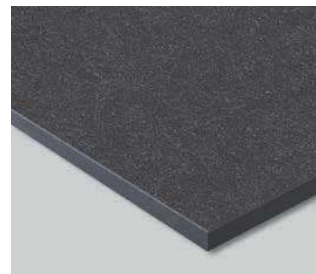

EQUITONE (natura)

Gyári méretek: 3130/2530 x 1280 mm
Alkalmazási terület: Homlokzat

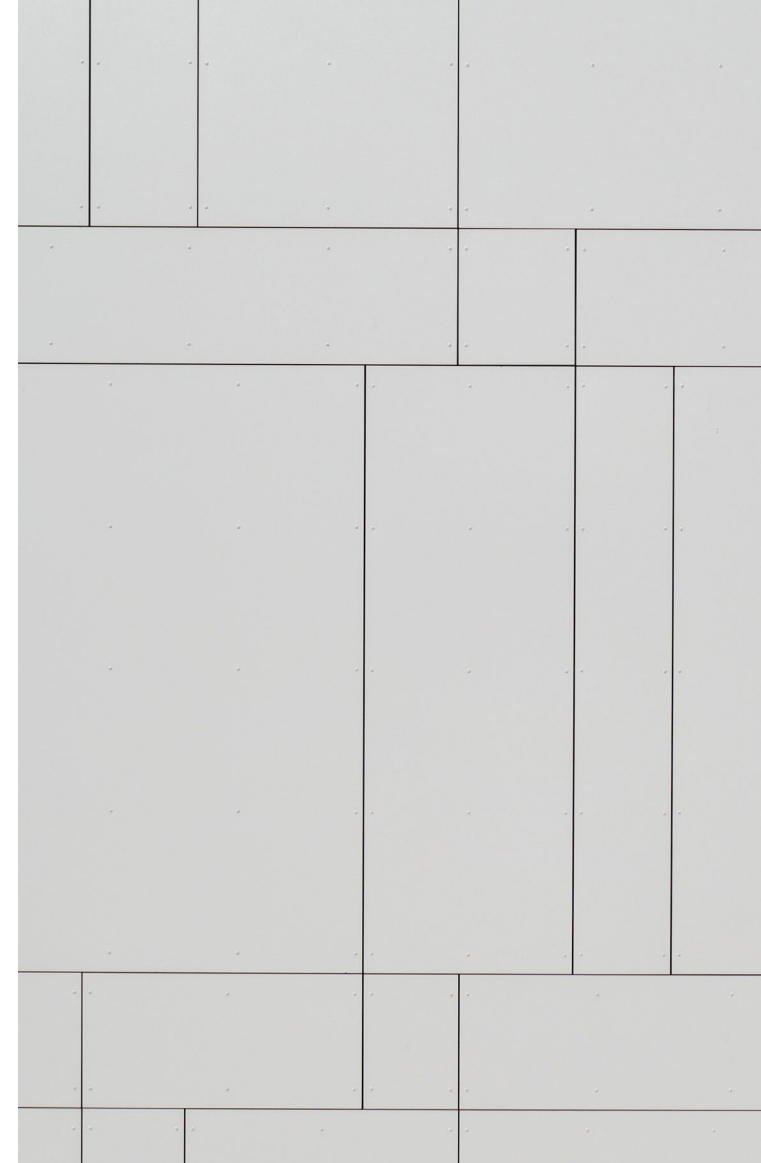



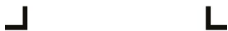

For you to create



Fundermax

 **EQUITONE**
Fibre cement facade materials



+3620 208 4844
info@designboard.hu